

# Fendt 200 Vario



**FENDT**

## The 200 Vario – true greatness in operation



More than 100,000 stepless Vario transmissions are in use at farmers and contractors today – the profitability, efficiency and driving comfort of Fendt Vario are regarded as unrivalled.

Now the time is also ripe for compact standard tractors: it is time to switch to the new Fendt 200 Vario. Experience the unmatched Fendt Vario technology, now also available in the 70 to 110 hp maximum power segment, and catch the excitement of continuously variable driving technology and ingeniously easy operation. Fendt has further developed this technology consistently – from now on, Fendt stands for 100 percent Vario.



<b>Fendt 207 Vario</b>	<b>51 kW</b>	<b>70 hp</b>
<b>Fendt 208 Vario</b>	<b>59 kW</b>	<b>80 hp</b>
<b>Fendt 209 Vario</b>	<b>67 kW</b>	<b>90 hp</b>
<b>Fendt 210 Vario</b>	<b>73 kW</b>	<b>100 hp</b>
<b>Fendt 211 Vario</b>	<b>81 kW</b>	<b>110 hp</b>

Maximum power kW/hp (ECE R 24)

#### Contents

Introduction	2 – 3
Vario overall profitability	4 – 5
Vario transmission	6 – 7
Cab and workplace	8 – 9
Operation	10 – 11
Engine	12 – 13
Cutaway diagram	14 – 15
Front axle suspension and manoeuvrability	16 – 17
Hydraulics and PTOs	18 – 19
Front loader 3X 65	20 – 21
Service and technical specifications	22 – 23

# 200 Vario – because overall profitability really counts

## Low costs per hour

The overall costs and the operating costs per hour are what count for the investment decision. These include fuel consumption, which is the single greatest factor amounting to about 60% of costs, write-off, as well as resale value, servicing, repairs and miscellaneous costs such as insurance or housing.

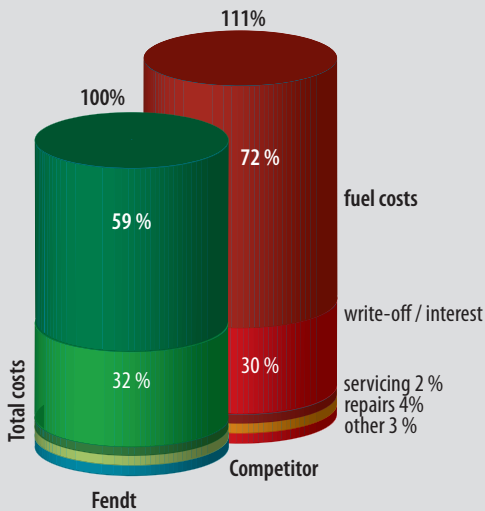

## Fuel consumption indicator

The fuel consumption indicator on the 300 Vario is located in the multi-display. It provides information about the average and current fuel consumption and has two memories. You simply have everything under control all the time.

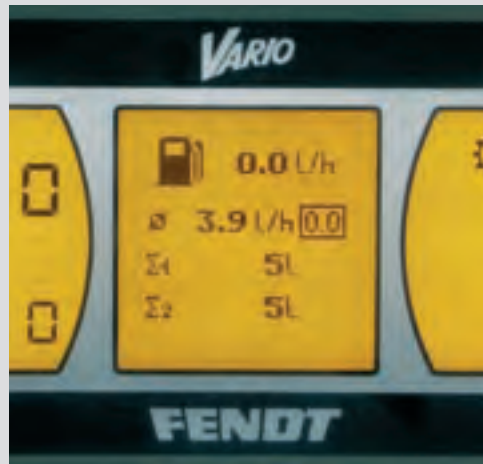

Farm type	area (ha)	working time	fuel savings
Mixed production	50	-2.7 %	6.5 %
	100	-3.3 %	6.5 %
	200	-4.3 %	6.8 %
Fodder	50	-6.8 %	8.7 %
	100	-6.6 %	8.3 %
	200	-5.5 %	8.0 %
Market fruit production	50	-4.4 %	6.5 %
	100	-4.6 %	6.4 %
	200	-4.4 %	6.4 %

Compared to drive concepts with power shift transmissions, the continuously variable drive technology offers savings potential for all types and sizes of farming businesses.

Source: Landwirtschaftliches Wochenblatt Westfalen-Lippe, 5/2001



**With the 200 Vario, Fendt offers a new dimension in compactness, productivity and efficiency. Now you can also profit from the superior Vario technology in the power segment from 70 to 110 hp maximum power. The Fendt 200 Vario, the first compact standard tractor with a continuously variable transmission, is distinguished by maximum profitability, cutting-edge equipment features and easiest operation. With a brand new design, the 200 Vario offers you a one-of-a-kind driving sensation and comfort as never before.**

**Compact high-tech – “Made by Fendt”**  
The Fendt engineers have made it possible, they have equipped the new 200 Vario with the technology of large tractors. As a compact standard tractor, the 200 Vario has exceptional driving dynamics and liveliness. Its compact block construction with a wasp-waist design permits maximum manoeuvrability. A low vehicle weight with a low centre of gravity ensures high stability – even in mountainous regions. The exceptional visibility and high-level technology enable convincing performance in all applications.



- Continuously variable Vario transmission from 70 to 110 hp maximum power
- Low unladen weight of only 3,870 kg (209 Vario)
- Compact dimensions and maximum manoeuvrability
- Low vehicle height
- Excellent visibility
- Enormous savings potential for time and fuel
- Highest level of driving comfort
- Best profitability in the total cost calculation
- Best retention of value

### **Overall profitability included**

The 200 Vario offers unheard of savings potential in time and fuel. Since fuel costs alone make up about 60 percent of the overall costs of a tractor, the high fuel efficiency of a Fendt Vario is a decisive factor for the profitability of your investment. You can perform your work faster and more effectively with the Vario – without gear steps. The optional Tractor Management System TMS, which automatically drives the tractor at an economical optimum, further enhances driving comfort.

### **Retention of value – a tradition at Fendt**

The retention of value of Fendt tractors is a fixed component of the economical advantages of a high-tech product. The forward-looking technology of the Varios is often first found on the market years later – Fendt sets the trends. With the Fendt 200 Vario, you are always at the forefront with the latest technology – you have a clear lead. This is the reason for the very high resale value of a Fendt, which will be a benefit to you after it has served many thousands of operating hours.

# Experience the one-of-a-kind Vario driving sensation

With the Vario transmission, you can drive forward and reverse at continuously variable speeds.

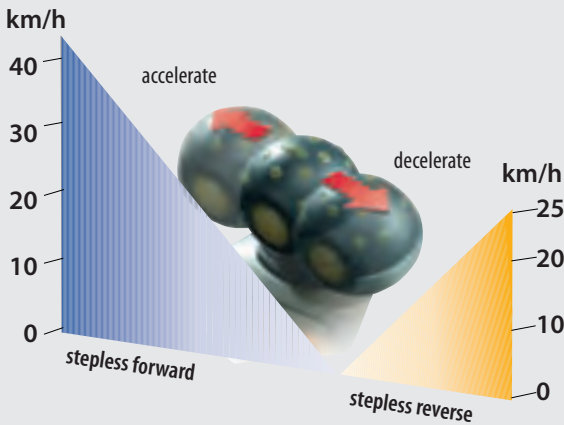

## Forward travel

Push the Variostick forward, the Vario accelerates forward from standstill until you have reached the desired speed.

## Decelerate

If you are going too fast, pull the Variostick back and the 200 Vario brakes the engine and transmission.

## Reverse

Pull the Variostick back and the Vario reverses from standstill. Faster or slower reverse speeds function in the same way as for forward travel.

## Rapid or slow acceleration

How rapidly or slowly you accelerate or decelerate with the transmission is determined by which of the two pre-set acceleration rates you select with the key.

## Cruise control

The cruise control maintains a constant pre-set speed. The key for activating the cruise control is conveniently located below the Variostick well within reach.

Ingenious design of the Vario transmission – the perfect combination of hydraulic and mechanical power transfer

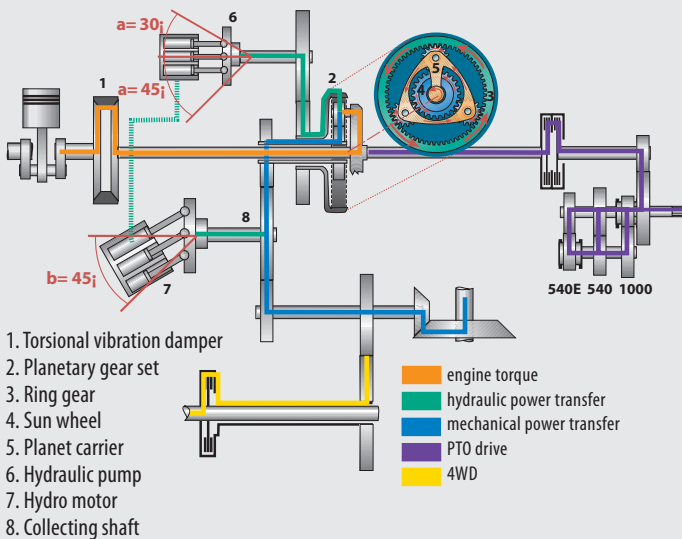

1. Torsional vibration damper
2. Planetary gear set
3. Ring gear
4. Sun wheel
5. Planet carrier
6. Hydraulic pump
7. Hydro motor
8. Collecting shaft

- engine torque
- hydraulic power transfer
- mechanical power transfer
- PTO drive
- 4WD

Different driving strategies for different operations. You can drive the Vario with either the Variostick or the foot pedal.

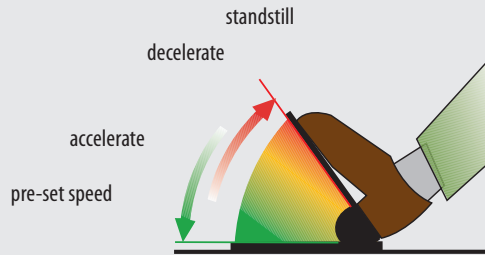

## Pedal driving mode

Set the direction you would like to drive with your left hand, then all that is needed to start the tractor is to press the driving pedal. In pedal mode, only the right foot is required to drive the tractor – similar to a car with an automatic transmission. The further the pedal is depressed, the faster the tractor goes.

**In the 200 Vario, the continuously variable Vario transmission proves just what it is capable of. Fendt offers the 200 Vario in an unprecedented performance level for this segment. Continuously variable speeds, a sophisticated suspension concept and excellent controls, mean higher working speeds and higher efficiency – all while keeping fuel consumption low. Numerous automated functions, such as cruise control or the Tractor Management System TMS, make your work easier than ever.**

**Precise driving – continuously variable**  
Driving without gear steps permits extraordinary sensitivity in operation. Thanks to the continuously variable Vario transmission, you can set the optimum ground speed independent of engine speed for any work to be done – no steps from 20 metres per hour to 40 kilometres per hour. The ingenious design of the continuously variable Vario transmission enables excellent efficiency, even at high working speeds.





- Maximum working performance with optimum fuel consumption
- Extremely fuel-efficient
- Highly efficient thanks to Vario
- Stability, even on slopes
- 40 km/h top speed at a fuel-saving 1750 rpm
- Ground speed can be set independent of the engine speed
- Cruise control
- Tractor Management System TMS \*

\* optional

### Constant driving speeds thanks to cruise control

The standard cruise control makes driving at a constant speed child's play. Two speeds can be stored in the instrument cluster, for example, one for in-field operations and one for the road. The cruise control activation button is conveniently located below the Variostick. You can reach it with your thumb, without having to take your hand off the speed control lever. The engine speed memory key is also located there is also actuated without changing grips.

### TMS Tractor Management System

Fendt offers the Tractor Management System TMS as an option for the 200 Vario. When TMS is activated, drivers only need to preselect the desired speed, then TMS controls the engine and transmission so that the tractor is always driving at an economical optimum. This not only saves fuel, it also maximises operating comfort.

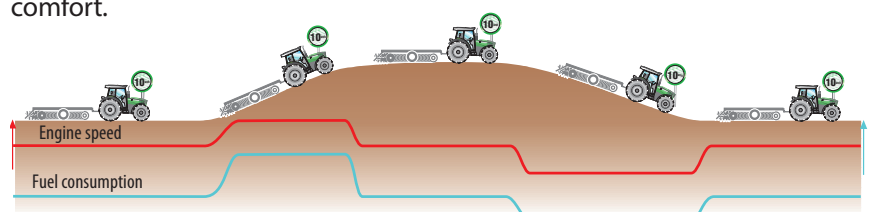

The Tractor Management System TMS ensures minimum fuel consumption.

## The comfort cab – plenty of space and functionality

### Flat cab floor

The flat cab floor on the new 200 Vario provides unprecedented legroom and makes climbing in and out easy. Another factor that increases legroom is that there are no operating elements in the foot area to get in the way.



### A roof window is standard

The 200 Vario has a roof window as standard, which provides best upward visibility during front loader work. The roof window can be opened upwards for additional ventilation in the cab. A retractable sun shade protects against intense sunlight.



### Greater ride comfort thanks to the optional cab suspension

The 200 Vario can be fitted with cab suspension as an option. The cab rests on conical rubber bearings at the front, so that it is isolated from vibrations emanating from the tractor body. The helical spring shock absorber system at the rear of the cab reduces shock loads to a minimum.



**The fully newly designed cab of the 200 Vario has a driver station that meets the highest demands. The cab offers an unprecedented amount of legroom, since there is no transmission tunnel. The centralised operating unit on the right-hand side, which integrates all the working and operating functions, as well as the height and tilt adjustable steering wheel, set new standards regarding operating ergonomics. Botherome gear shift levers or controls in the foot area are a thing of the past.**



### Comfortable driver station

A flat floor is new in the 200 Vario cab. It permits easy entry and exit as well as an optimum leg position, since there is no transmission tunnel to get in the way. It is now standard for the 200 Vario. The centralised operating unit is located on the right-hand side – there are no bothersome operating elements in the foot area. The height and tilt-adjustable steering wheel and the comfort seat with air suspension (optional) ensure you are in the right position to stay fit on long working days.



- Easy to enter and exit
- Comfortable legroom
- Best visibility in all directions
- Optimum sound-proofing
- Height and tilt-adjustable steering wheel
- Perfect working environment with optional air-conditioning
- Passenger seat is standard
- Superior lighting concept
- Cab suspension optional

#### **Perfect working environment – quiet cab**

The powerful heating and ventilation system creates an optimum working climate. For even greater comfort, the 200 Vario can be fitted with optional air-conditioning. The optimum design of the cab keeps the noise level very low.

#### **Passenger seat is standard**

Passengers sit comfortably on the standard passenger seat, which offers plenty of space and enables a good sitting position.

#### **Best visibility in all directions**

The generous glass areas and the narrow steering column provide an optimum view to the implements at all times. The roof window provides ideal upward visibility for front loader work.

#### **Optional cab suspension**

The already very high ride comfort of the 200 Vario can be further enhanced with optional cab suspension. The optimum cab bearing reduces shock loads and provides a one-of-a-kind driving experience.

# The Vario controls – easy, faster and better

Everything in one hand with the Variostick



The main gear shift lever, range lever and super crawler gear shift lever are now redundant. You can operate all of them with the Variostick.

Control panel on side console.



Controls for central information display

Engine speed memory

Cruise control memory

TMS (optional) controls

Steering column



The height and tilt adjustable steering wheel allows each driver to find the ideal sitting position.

Instrument cluster



Speed display

Central information display

Ground speed display

**The 200 Vario impresses every user through its easy and intuitive operation. Practically arranged, all the operating elements are centrally located on the right-hand operating console. You can control any speed between 20 metres per hour and 40 km/h continuously with the Variostick, without having to change controls. All the information is available at a glance on the newly designed dashboard, which includes the instrument panel and a central information display. The 200 Vario operating concept – optimum ergonomics for fast and precise work.**

## Variostick control:

### all in one – ingeniously easy

With the 200 Vario, strenuous shifting is a thing of the past, because the Variostick integrates everything into one: a main gear shift lever, range lever and crawler gear lever. The Variostick is ergonomically placed on the right-hand console. With just one single hand movement, you can set the desired speed with the Variostick. When the Variostick is pulled back, the Vario continually decreases the travel speed, without gear steps, until the tractor is stationary.



- Easiest operation via Variostick
- Exemplary ergonomics and clutter-free cab concept
- Comfortable armrest \*
- Electronic hand throttle
- Comfort controls for 4WD, differential locks and PTO
- Information display for all the important settings
- Easy direction changing
- Stop & Go function in combination with TMS \*

\* optional

### Central information display

Drivers can make all the important settings, such as for the engine speed, cruise control speed, TMS or 4WD and differential lock automatic mode, using the central information display. The multi-display on the dashboard shows all the information, including fuel consumption, so that drivers have everything in full view.

### Easy direction changing

Only one hand movement is necessary to change direction. You can change driving direction easily with your right hand using the

Variostick. For front loader work, you can change directions with your left hand using the switch on the steering wheel adjustment lever. That leaves your right hand free for operating the hydraulics.

### Stop & Go function together with TMS\*

With the optional Stop & Go function, drivers can slow the 200 Vario down to a stop by pressing and holding the switch on the reverser. When the switch is released, the tractor drives in the direction that the switch was pushed.

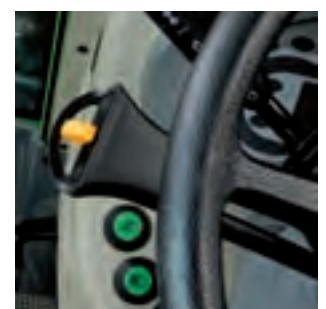

With the reverser, you can change directions easily with your left hand.

# The 200 Vario – performance redefined



The external EGR system provides targeted cooling of recirculated exhaust, which lowers fuel consumption considerably compared with internal exhaust gas recirculation systems.

The latest technology in engine design has been implemented in the 3-cylinder AGCO-Sisu Power engines, which allows the 200 Vario to attain high performance values while keeping fuel consumption low.

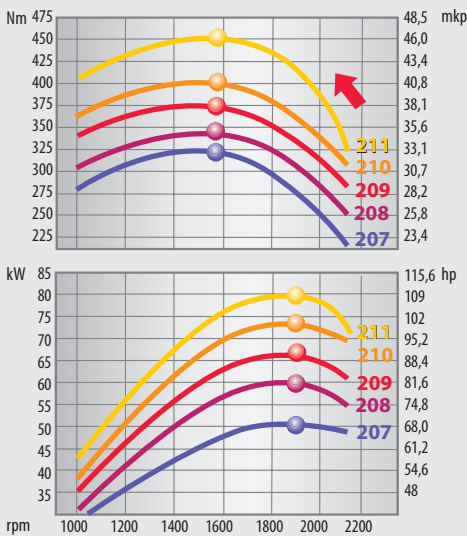

458 Nm torque, 110 hp max. power at 1,900 rpm and a specific fuel consumption of 210 g/kW for the 200 Vario thanks to implementation of the latest engine technology.



The air filter with cyclone precleaner stands for maximum efficiency, despite the small installation space in compact tractors.



**The 3-cylinder AGCO-Sisu Power engine was specially developed for the new 200 Vario in collaboration with engineers from Fendt. It is characterised by liveliness, high torque as well as exceptionally smooth running. The engine is also very fuel-efficient. The generous design of the cooling system guarantees high operational security, even during demanding work.**

### Powerful engine – economical fuel consumption

The water-cooled 3-cylinder AGCO-Sisu Power engine is very compact so that the tractor dimensions could be kept small for best manoeuvrability. The engine speed-controlled common rail high-pressure injection system and the fully electronic engine control guarantee high performance and a low noise level. This allows the 200 Vario to drive at an economical optimum, which makes it extremely fuel-efficient.



- **3-cylinder-AGCO-Sisu-Power engine, compact design – specially developed for the 200 Vario**
- **Large fuel tank, 124 litres**
- **Compact cooler unit for maximum operational reliability**
- **High-level technology for reduced fuel consumption**
- **Common rail injection technology with external exhaust gas recirculation**
- **Suitable for use with RME biodiesel**
- **Air filter with cyclone pre-cleaner guarantees long filter life**

#### **AGReX – economical and environmentally-friendly**

The high-performance injection system and the AGReX external exhaust gas recirculation system complement each other. Combustion is optimised through cooling and exact proportioning of recirculated exhaust. This significantly lowers fuel consumption and minimises costs per hour.

#### **High efficiency cooling**

The newly designed cooling system on the 200 Vario has large intake areas. This results in less dirt in the radiator and optimised cooling performance, even during extreme operating conditions. The air filter with cyclone pre-cleaner guarantees a high filter life and less maintenance work. It permits high air flow despite the small installation space.



The 200 Vario can be used with RME biodiesel without restrictions. The use of rape methyl ester according to DIN EN 14214 is fully approved by the manufacturer as standard specification. This allows you to profit from enormous cost benefits, because you do not require additional insurance and alterations are not necessary.

## An overview of the 200 Vario

1. Front axle with 52 degree steering angle
2. Self-levelling front axle suspension - hydraulic cylinders with +/- 40 mm suspension travel
3. Wasp-waist design
4. Front power lift
5. Front PTO
6. Planetary final drives
7. 3.3-l turbo three-cylinder
8. Cooling system
9. AGReX external exhaust gas recirculation
10. Stepless Vario transmission
11. Planetary gear set
12. Hydro motor
13. Hydro pump
14. Enclosed 4-WD clutch
15. Nitrogen pressure accumulator (suspension)
16. Planetary axle
17. Comfort cab
18. Mechanical cab suspension
19. Air-sprung Fendt comfort seat
20. Variostick for controlling the stepless Vario transmission
21. Fendt cockpit with multi-display
22. Hinged viewing window with roller shade
23. Auxiliary work lights

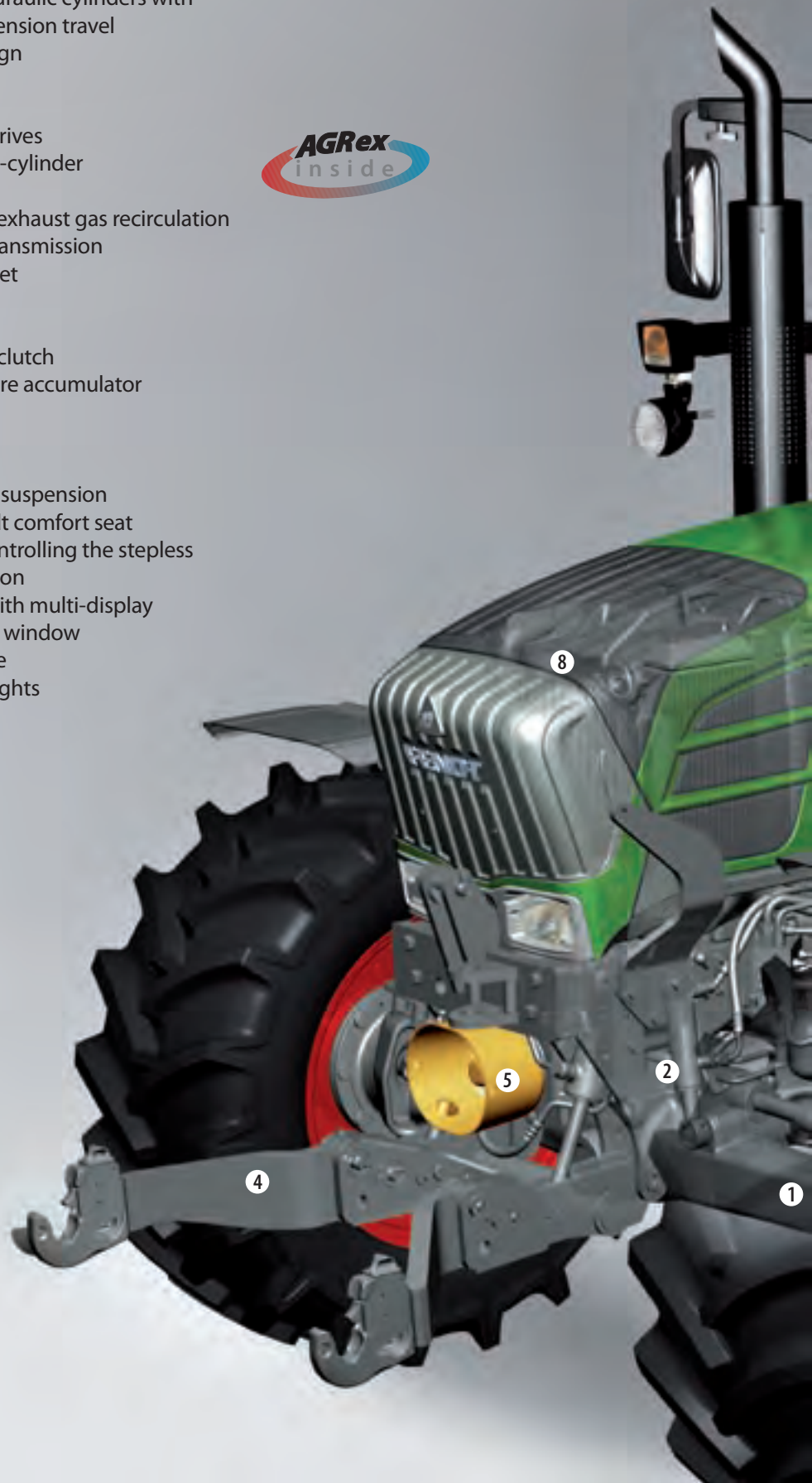



# Safe and stress-free work

## Fendt front axle suspension for greater safety

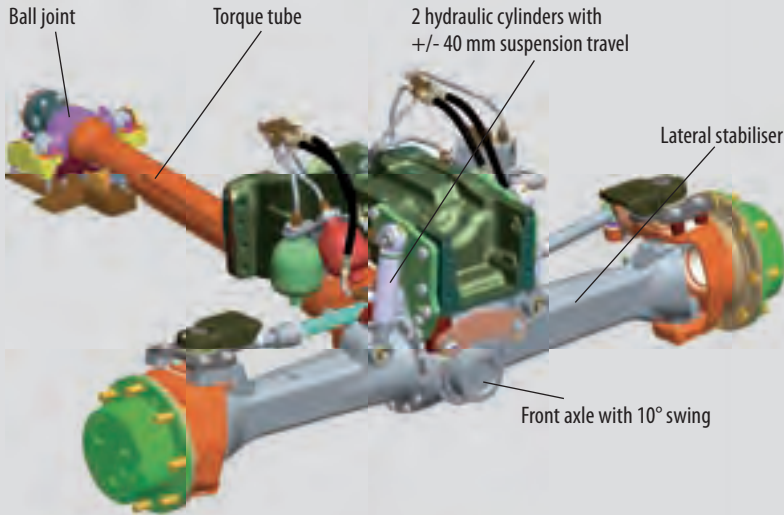

### Suspension design

- Hydropneumatic, level-controlled suspension with hydraulic cylinders, nitrogen reservoirs and lateral stabiliser
- Functions: suspension, level control, lock and anti-roll control
- Activation and control via hydraulic block and the electronics integrated in the tractor

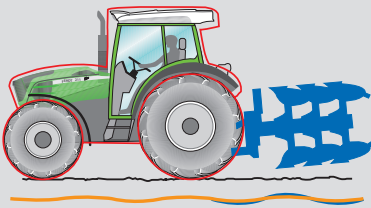
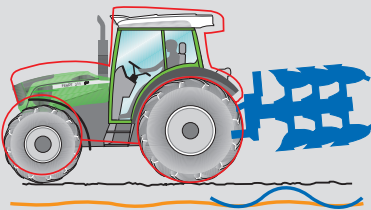

### EPC with shock load stabilising for exclusive ride comfort

The shock load stabilising system works like an electronic shock absorber when driving with rear-mounted implements on the road and in the field. This allows quiet, fast and safe driving without annoying vibrations.

## Highest manoeuvrability

The secret of the exceptional manoeuvrability of the 200 Vario lies in the combination of the wasp-waist design of the tractor body and the 52 degree steering angle.

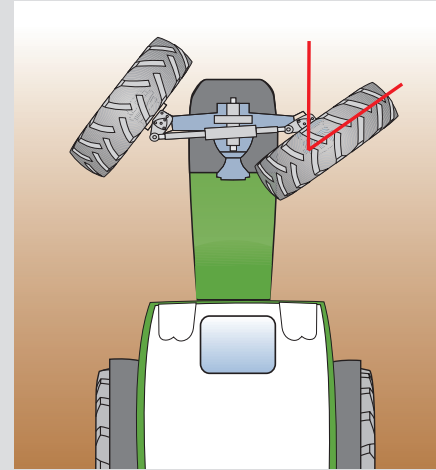

### Pivoting mudguards

The 200 Vario can be fitted with pivoting front mudguards as an option. They maximise the wheel angle and permit a turning circle of only 3.98 metres, even with low-profile tyres.

**The self-levelling front axle suspension on the Fendt 200 Vario guarantees maximum ride comfort, best driving safety and optimum traction. This provides considerable advantages, especially on slopes, since all four wheels are in contact with the ground longer. Anti-roll control ensures safety and stability when working with a front loader or on slopes. With active shock load stabilising and lifetime high-performance brakes, the 200 Vario has unprecedented ride comfort.**

**Exceptional ride and operating comfort**  
The intelligent combination of three systems guarantees maximum ride and operating comfort: the self-levelling front axle suspension with anti-roll control, the cab on silent bearings and the active shock load stabilising. This reliably minimises shock loads and counteracts uneven ground on the road and in the field – by up to 20 percent. Level control permits high payloads and ensures a constant, high degree of suspension comfort even with high loads.



- Unparalleled operating and ride comfort
- Suspension comfort remains constant thanks to level control
- Maximum steering precision, driving stability and braking safety through anti-roll control
- Best transfer of power through optimum ground contact
- Lockable for precise control of implements and convenient mounting and removing of front-mounted implements
- Less wear on tractor and implements
- Best manoeuvrability through 52° steering angle, wasp-waist design and 3° caster angle
- Excellent straight-ahead driving and stable handling
- High ground clearance 475 mm (front tyres 270/80 R32)\*

\* below front axle

### Front axle suspension

The front axle, which is pushed by the torque tube, detects uneven surfaces and transmits these findings to hydraulic cylinders. The oil displaced in the cylinders presses against the nitrogen reservoirs, where the shock loads are dampened. The integral automatic level control with position sensor, guarantees constant suspension comfort independent of load. Anti-roll control guarantees a high degree of stability and operating safety, especially when working with mounted implements.

### Maximum manoeuvrability and stability

The chassis of the 200 Vario meets the requirements of a compact tractor 100 percent. The wasp-waist design ensures exceptional manoeuvrability and a 52 degree steering angle. The low vehicle weight of the 200 Vario guarantees that soil compaction is minimised during operation. The high stability of the 200 Vario results from the chassis's low centre of gravity. The optimum traction and constant power engagement of the Vario transmission allow you to work safely and without stress, even on slopes.

# Optimum control of hydraulics and PTO

## Practical control centre for the EPC

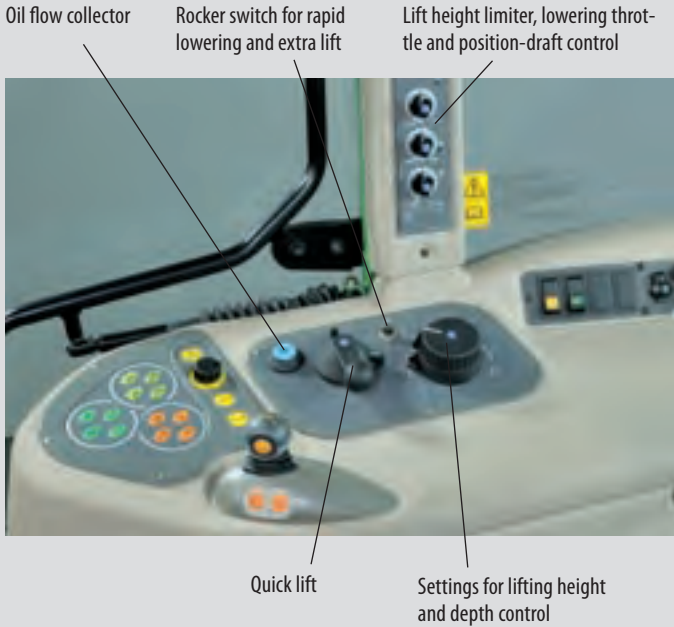

Save yourself unnecessary steps – ergonomic and convenient controls for the PTO shafts:

## Rear actuation



## Right-hand control console

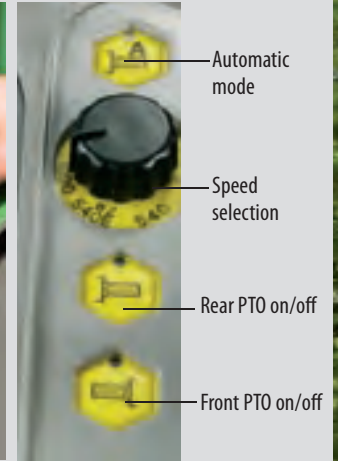

The 200 Vario has external controls for the power lift and rear PTO. You can mount rear implements easily and save yourself unnecessary steps, for example, when filling the slurry tank.



Valves 1 and 2 can be controlled very precisely with the crossgate lever.



Clear arrangement of the hydraulic connections and clutter-free linkage design concept.

**The 200 Vario is a genuine all-rounder and very versatile tractor. The powerful hydraulics enable the fast lifting movements and high oil delivery capacities required by modern implements. The operations of the PTO and 4WD and differential lock engagement in the operating console is extremely easy, for optimum control of your implements.**

### Powerful hydraulics

The hydraulics on the 200 Vario have a high oil delivery capacity of max. 48 litres as standard. If

a particularly high delivery capacity is required, the driver can engage the optional tandem pump for a combined oil flow with a max. delivery capacity of 76 l/min.

### Separate, clean hydraulic oil supplies

The separate hydraulic and transmission oil supplies prevents oils from mixing – especially important if hydraulic implements are changed frequently. The use of bio-hydraulic oils is unrestricted.



- Single pump: hydraulic oil delivery capacity 48 l
- Tandem pump\*: hydraulic oil delivery capacity 76 l
- Maximum lift capacities:  
Rear: 4204 daN  
Front: 2490 daN
- EPC rear linkage
- Up to four mechanical auxiliary control valves
- Oil flow for valves 1 and 3 can be adjusted
- Max. available hydraulic oil: 34 litres
- Bio-oils can be used for the hydraulics
- PTO speeds  
540/540E/1000 rpm
- Ground PTO  
540/ground/1000\*
- Front PTO speeds 540 or 1000\*

\* optional

#### **EPC rear power lift with reserves**

The electrohydraulic rear linkage with a maximum lift capacity of 4204 daN guarantees that even the heaviest rear-mounted implements for this power class can be lifted fully.

#### **Integral front linkage with damping**

The optional front linkage has a maximum lift capacity of 1490 daN. Its rugged construction makes it suitable for all kinds of operations. The integral nitrogen reservoirs guarantee driving safety and comfort even when carrying heavy loads.

#### **High PTO power easy to operate**

The PTO engagement control has 3-speed preselection. The standard PTO automatic mode automatically engages and disengages the PTO, depending on the height of the linkage. Automatic PTO start-up protects your PTO implements with a smooth start-up – you profit from lower servicing costs and longer service life of your implements.

## The tailor-made design: Vario and CARGO front loader



With the Fendt CARGO Lock, you can mount and remove the CARGO front loader from your 200 Vario even faster and easier. Thanks to the semi-automatic lock, you no longer need to deal with inserting locking bolts, which is often difficult. The system also offers optimum operational safety, since the front loader is locked in place immediately after driving into it.

A multi-coupler connects all hydraulic and electric lines at once – even under pressure on the front loader side. The front loader can be mounted and removed in the shortest amount of time.

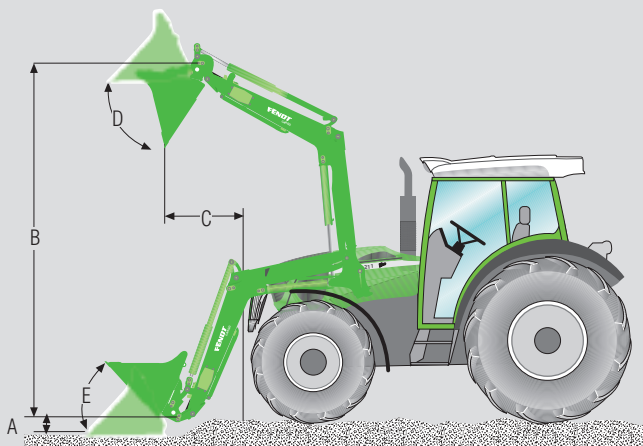

Model	3X/65
<b>A</b> Digging depth (mm)	210
<b>B</b> Lifting height (mm)	3740
<b>C</b> Dumping dist. (mm) B = 3.5 m	1170
<b>C</b> Dumping dist. (mm) B = max.	860
<b>D</b> Angle of emptying	55°
<b>E</b> Angle of backwards tilt	48°
Lift capacity over full height (daN)	1680
Max. lift capacity (daN)	1850

A 200 Vario equipped with an original CARGO front loader from Fendt makes front loader operations extremely easy.



**Fendt offers the new Fendt CARGO 3X 65 exclusively for the 200 Vario. Like the other Fendt front loaders, the new front loader is also "Made by Fendt". An in-house development, the new Fendt front loader has been ideally adapted to the 200 Vario tractor range. Designed according to the tried and tested system, the compact front loader 3X 65 unites all the advantages of the Fendt CARGO with compact dimensions and easy handling. Comfort, safety and service-friendliness also meet the high Fendt standards.**

### Custom-made design

The 200 Vario and the Fendt CARGO 3X 65 build a perfect unit. The coordinated, in-house development of the tractor and the front loader guarantees the optimum combination of all components. From the very beginning, all the dimensions and forces of the CARGO were explicitly adapted to the compact Vario. The results are high operational safety and the best visibility along with balanced distribution of forces and loads.



- Vario and the front loader – were developed together as a perfect unit
- Roof window for best upwards visibility
- Lift capacity over full height: 1680 daN
- Lifting height: 3770 mm
- All pipes run in the frame
- Valves for 3rd and 4th hydraulic circuits lie protected in the cross beam \*
- Euro quick-attach frame (optional SMS frame)
- Multi-coupler for mounting front loader (standard)
- Multi-coupler for 3rd and 4th hydraulic circuit on Euro quick-attach frame \*
- Wide range of original Fendt attachments \*

\* optional

### Handling at its best

The operating concept was designed for optimum driving comfort. The standard crossgate lever provides precise control of the CARGO. The optional third or fourth hydraulic circuits, are activated via push-buttons on the crossgate lever and then easily controlled with the crossgate lever. Through a specially designed connection between the front loader and the tractor, all maintenance work can be performed on the 200 Vario tractors while the front loader is attached.

### Tried and tested system: CARGO Lock

The front loader for the 200 Vario has also been equipped with the well-proven CARGO Lock system from the larger Vario ranges. The front loader can be conveniently mounted and removed in a short amount of time.

# Innovative technology, intelligent service – all from one source

## Know-how through practical training

Profit by technically and economically optimising operations with your Fendt tractor, whether in the field, on the road or in the books. Professional instructors show you how to utilise top class technology efficiently and safely, in theory and practice.



## Fast diagnostics thanks to FENDIAS

StarService technicians use FENDIAS to gain access to the digital data inside your Fendt. If required, data is also gathered and analysed while the machine is running – for example, data from the hydraulics or the transmission. All for the sake of fast fault diagnostics and operational availability.



## Fendt StarService Emergency Hotline

Available 7 days a week!<sup>1)</sup> Fendt StarService Partners are mobile and have only one objective: to keep your Fendt operationally available, primarily through preventative measures. Should something actually happen, the Emergency Hotline is available for fast and competent help – even on-location at your farm or business!  
<sup>1)</sup> during the harvesting season from May to October



## Genuine Fendt parts – so that your Fendt remains

**100% Fendt:** Genuine Fendt parts are tailored to your Fendt. They carry the assurance of series quality and are tested for functional reliability. That pays off in many ways: – 12 month warranty on genuine Fendt parts and their installation – the highest level of operational reliability – top resale value

## Mobile expert service

Every StarService partner has a modern service vehicle. Tried and test, optimised tools, as well as service documentation and FENDIAS, the computer-supported analysis and diagnostics system, are always on board. This allows mobile StarService technicians to localise and rectify errors quickly.

## Fendt24 – because your time is invaluable!

Your StarService partner has the most commonly required parts in stock. If a part is not in stock, we deliver those that are ordered by 18:00 by 8:00 the next morning. Your StarService partner has access to Fendt24 during the harvesting season<sup>1)</sup>. Here orders are taken around the clock and are ready for delivery within two hours.

## Profitability under contract

With a Fendt Service Package, you have servicing and repair costs under control. Would you like to have the prescribed servicing work done on the basis of reasonable fixed costs? Or do you want full control of costs per operating hour without unpleasant surprises? Choose between the Service, ProService and FullService packages.

## Tractors for rent

Rent a tractor, including the Service Package, at a fixed cost through your Fendt StarService partner. This frees up your funds and you can easily calculate the costs per hour. If desired, we can take over all servicing work, complete insurance coverage and repairs\*.

\* Repairs according to FENDT warranty policy; natural wear (e.g. tyres) and malicious damage are excluded.

# Technical specifications

# Standard equipment Additional equipment

	207	208	209	210	211
<b>Engine</b>					
Rated power (kW/hp) ECER24	44/60	52/70	59/80	66/90	74/100
Max. power (kW/hp) ECER24	51/70	59/80	67/90	73/100	81/110
Rated power (kW/hp) EC 97/68	52/71	60/82	67/91	73/99	74/101
Max. power (kW/hp) EC 97/68	55/75	63/85	70/95	77/105	85/115
No. of cylinders/cooling	3/water	3/water	3/water	3/water	3/water
Bore/stroke (mm)	108/120	108/120	108/120	108/120	108/120
Cubic capacity (cm <sup>3</sup> )	3300	3300	3300	3300	3300
Rated engine speed (rpm)	2100	2100	2100	2100	2100
Opt. fuel consumption (g/kWh)	212	212	210	210	210
Max. torque (Nm/rpm) 1600 rpm	295	337	373	408	458
Torque rise (%)	34	32	30	30	42
Fuel tank capacity (l)	125	125	125	125	125
<b>Transmission and PTO</b>					
Type	stepless Vario transmission				
Speed range (forward / reverse)	0.03 to 40 km/h / 0.03 to 25 km/h				
Maximum speed (km/h) <sup>2)</sup>	40	40	40	40	40
Powershiftable rear PTO standard/upon request	540 / 540E / 1000 – 540 / ground / 1000				
Engine speed for rear PTO rated speed	540 and 1000 rpm PTO: 1900 rpm 540E PTO: 1560 rpm				
Powershiftable front PTO <sup>1)</sup>	540 <sup>1)</sup> or 1000 <sup>1)</sup>				
<b>Hydraulics</b>					
Type	Electrohydr. power lift control (EPC) with shock load stabilising				
Control	free floating, position, draft and inf. adj. mix control				
Hydraulic pump capacity (l/min)	single pump (48 l/min); tandem pump (35 l/min + 41 l/min) <sup>1)</sup>				
Working pressure (bar)	200	200	200	200	200
Auxiliary control valves, max. centre/rear	2/4	2/4	2/4	2/4	2/4
Max. available oil volume (l)	34	34	34	34	34
Flow volume control valves	1. valve: 5-65 litres, 3rd valve with 5-65 litres <sup>1)</sup>				
Max. lift capacity, rear linkage (daN)	4204	4204	4204	4204	4204
Max. lift capacity, front linkage <sup>1)</sup> (daN)	2490	2490	2490	2490	2490
<b>Brakes</b>					
Rear brakes	wet ring piston brake				
Four-wheel braking system for 4WD	automatic 4WD engagement				
<b>Electrical equipment</b>					
Battery (Ah)	90				
Three-phase alternator	14V / 120A				
<b>Weights and dimensions</b>					
Unladen weight with cab (kg)	3750	3790	3870	3870	3930
Max. perm. overall weight (kg)	6500	6500	6500	6500	6500
Max. hitch load (kg)	2000	2000	2000	2000	2000
Overall length (mm)	4068	4068	4068	4068	4068
Overall width (mm)	1970	2170	2170	2170	2186
Wheelbase (mm)	2294	2294	2294	2294	2294
Min. turning circle to ISO 789/3 (m) w/o steering brake with track 1700mm	3.98	3.98	3.98	3.98	3.98
Overall height comfort cab (mm)	2480	2480	2530	2530	2530
Max. ground clearance (mm)	445	445	445	445	445
Track width front (mm)	1500	1500	1690	1690	1690
Track width rear (mm)	1510	1655	1660	1660	1660
<b>Tyres front</b>	<b>Tyres back</b>				
320/70 R 24	420/85 R 30	■	□	□	□
320/70 R 24	480/70 R 30	□	■	□	□
380/70 R 24	480/70 R 34	□	□	■	□
440/65 R 24	540/65 R 34	□	□	□	■
270/80 R 32	270/95 R 44	□	□	□	□
425/75 R 20	600/65 R 30	□	□	□	□

<sup>1)</sup> Upon request

<sup>2)</sup> Speed depends on tyres

<b>Engine</b>	
Water-cooled turbo engine	■
AGReX external exhaust gas recirculation	■
Air filter precleaner (integrated)	■
Automatic cold-start	■
Engine preheater	□

<b>Transmission</b>	
Turboclutch function	■
Cruise control, auto. max. output control	■
Vario™ engine-transmission management system	□

<b>PTO</b>	
Rear 540/750/1000 rpm	■
Rear 540 ground 750 rpm	□
Front 540 rpm or 1000 rpm	□
PTO engagement control, electrohydr. preselection	■
External controls for rear PTO	■

<b>Chassis / driving safety</b>	
Front axle suspension with level control	□
Schock load stabilising, EPC power lift	■
Compressed air system	□

<b>Power lift</b>	
Electrohydraulic power lift control EPC with shock load stabilising	■
EHL power lift	□
Quick coupler	■
Front power lift	□

<b>4WD/differential locks</b>	
Comfort controls 4WD/differential locks speed-controlled	■
Automatic front differential lock	■
Rear differential with disc locking	■
Fully protected drive shaft	■

<b>Hydraulics</b>	
Single hydraulic pump, hydraulic oil cooler (max. 48 l/min)	■
Tandem hydraulic pump, hydraulic oil cooler (max 76 l/min)	□
Crossgate lever	■
External controls for rear linkage	■

<b>Cab</b>	
Variostick control	■
Height and tilt-adjustable steering column	■
Hot water heating with inf. adj. blower	■
Comfort seat with fore to aft suspension, lumbar support	■
Comfort seat with air suspension	□
Hinged front / rear windows	■
Roof window, hinged, with roller shade	■
Self-cancelling indicators	■
Toxic filter	□
Integral air conditioning system	□
Rear work lights	□
Additional lights, front (integral)	□
Telescoping rear view mirror	■
Speed socket	■

<b>Additional equipment</b>	
Weights	□
Rear hitch	■
Automatic hitch with remote control, rear	□
Ball coupling	□
Swinging drawbar	□
Piton-fix	□

■ Standard  
□ Optional  
- not available

## 200 Vario – compact can be so big



Sales agent:

200V/1.1-GB/02-10/5.5-E

All data regarding delivery, appearance, performance, dimensions and weight, fuel consumption and running costs of the vehicles correspond with the latest information available at the time of going to press. Changes may be made before the time of purchase. Your Fendt dealer will be pleased to supply you with up-to-date information.

 **AGCO**  
Your Agriculture Company

AGCO GmbH – Fendt Marketing  
87616 Marktobendorf, Germany  
Fax +49 (0) 8342 / 77-220  
[www.fendt.com](http://www.fendt.com)